

# ***PROBE ENGINEERING, INC.***

## **Installation Instructions**

### **Model FS-02E Ignition System**

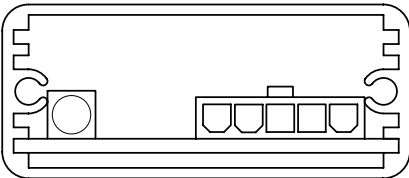

**Control Module**

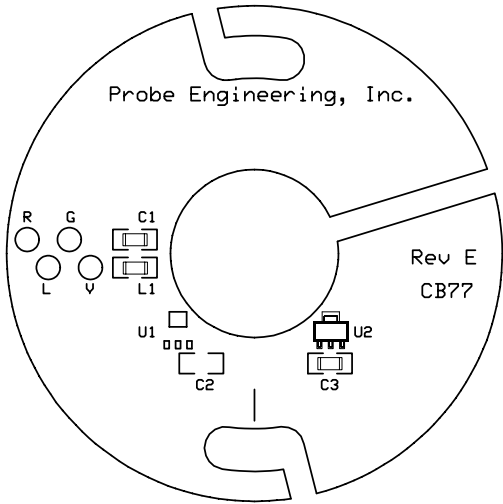

**Pickup Plate**

**Trigger Rotor**

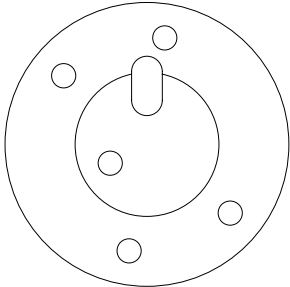

**Rotor Clamp**

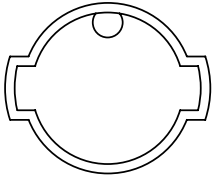

# ***PROBE ENGINEERING, INC.***

## **Installation Instructions, Model FS-02E Version 7.1**

The Model FS-02E electronic ignition is designed specifically for 1960s Honda models 250 Dream (CA72) and 305 Dream (CA77) with Type 2 engines. The Type 2 engines are differentiated by having their crankpins disposed at 360°, and have one carburetor, one set of breaker points, and one dual-tower ignition coil serving both spark plugs.

Note: Known good resistor-type spark plug caps or resistor-type plugs MUST be used with the FS-02E ignition system. 40-year-old OEM resistor caps are usually shot; the best insurance is a pair of new NGK resistor plug caps, widely available from parts retailers for a few dollars each.

The FS-02E system incorporates a “timeout” circuit that automatically shuts off ignition coil current if it senses the engine has been stopped for 30 seconds. This prevents damage to the coils and module in the event the key switch is inadvertently left in the on position. The timeout circuit is automatically reset when it senses engine rotation; it is not necessary to cycle the key switch off and back on to re-enable system operation.

### **What should be in the kit:**

The Model FS-02E kit includes the following components:

- ◆ Control Module
- ◆ Pickup Plate Assembly (with shielded leads and five-pin connector)
- ◆ Trigger Rotor
- ◆ Rotor Clamp (modified Oetiker-brand clamp)
- ◆ Power Cable Harness (with 4-pin connector)
- ◆ Self-adhesive Velcro pads (for mounting the module)

### **What else you will need:**

In addition to the usual small hand tools required to get access to the engine’s breaker-points assembly and to remove the fuel tank, side panels, etc., installation will require the following tools and supplies:

- ◆ End-cutting pliers (or the Oetiker clamp installation tool, if you have access to one)
- ◆ Wire cutters/strippers
- ◆ Solderless crimp-type connectors, bullet connectors, or solder and shrink tubing
- ◆ Loctite medium-strength (blue) thread-locking compound or equivalent

# ***PROBE ENGINEERING, INC.***

## **Installation Instructions, Model FS-02E Version 7.1**

### **Installation:**

1. Remove the right and left side panels.
2. Disconnect the battery.
3. Remove the alternator rotor cover.
4. Remove the two-part alloy trim pieces that cover the frame structure just behind the carburetor's inlet.
5. Remove the breaker-points cover.
6. Remove the breaker points and their backing plate as a complete assembly.
7. Disconnect the breaker points from the ignition coil and condenser. You won't be using any of this wiring; you can tie up and tuck out of the way any unused bits that may be left attached to the bike.
8. Thoroughly clean and degrease the points cam with solvent. Commercial brake cleaner works well for this – wet a rag or paper towel with solvent and scrub the cam clean, including the end of the shaft.
9. Using the original screws from the points backing plate, install the new Pickup Plate into the recess formerly occupied by the points backing plate. Don't tighten the screws yet. (You will note that the pickup plate says "CB77" in silkscreen ink at the right edge, that components U1 and C2 are not soldered to the PC board, and that terminal "L" has no wire soldered to it; this is all correct for the FS-02 application.)
10. Check to see that the pickup plate can be rotated in the housing with the screws loose. It's a close fit and will sometimes bind if the housing has any damage or is a little small. Center the pickup plate's mounting-screw slots on the screws (there is a white silk-screened line dead center just above the lower screw slot). Snug up the screws finger-tight; you'll have to loosen the screws again later to finalize the ignition timing.
11. Carefully seat the grommet carrying the pickup leads into its recess in the points housing. Leave a little play in the wires so that the pickup plate can be rotated later to finalize the timing.
12. Route the wires from the pickup plate over the cylinder head similar to the original breaker-points leads.

# ***PROBE ENGINEERING, INC.***

## **Installation Instructions, Model FS-02E Version 7.1**

13. Locate the Control Module in the kit. It looks like this:

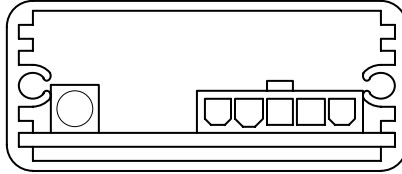

14. There is a 5-pin connector at the right side of the module (into which the pickup plate lead-wires plug) and a red LED at the left side. There is also a 4-pin connector (not shown in the line drawing) at the end of a short wire bundle coming out the module; this connects to the Power Cable Harness.
15. Find a place where you'd like to mount the module. It's best not to have it directly exposed to radiated engine heat. The module dissipates very little power during operation, and its self-heating is minimal – it will get barely warm to the touch. The self-adhesive Velcro provided in the kit may be used to mount the control module to a clean, dry surface. Don't mount the module so that it's "upside-down;" if it hangs from the Velcro so that gravity wants to pull it straight off, gravity (and vibration) will eventually succeed in doing just that.
16. Route the pickup assembly's shielded lead wires to the location of the control module. The pickup plate wires are insulated using high-temperature Teflon, and have a tinned-copper braided shield surrounding them; the wires can be routed pretty much anywhere (except to an exhaust pipe!) without major temperature concerns. **However, the pickup wires must be kept well away from the ignition coil, the spark-plug leads, and the red, green, and yellow power-harness wires (which you will connect later), so that the electronics won't get confused or damaged by spark-energy "pickup."**
17. The pickup assembly's wire bundle has a plug that matches the module's 5-pin connector housing. Plug them together; they are keyed, so that they only fit one way. The retaining latch will "click" when the connectors are fully mated.

**The next series of steps tells you how to connect the Power Cable Harness to your bike's electrical system and to the ignition coils. The last step in the sequence, #23, instructs you to plug the 4-pin harness connector into the matching module connector. Do not plug them together until the wiring steps (beginning at #18, below) have been completed and double-checked.**

# ***PROBE ENGINEERING, INC.***

## **Installation Instructions, Model FS-02E Version 7.1**

18. There is a 4-pin connector on the Power Cable Harness. On the connector's rear surface (where the wires enter), molded-in numbers show each wire's position, 1 through 4. The wires in each position are as follows:

|                      |  |
|----------------------|--|
| ◆ <b>Position 1:</b> | <b>Heavy-gauge red wire – goes to switched +12 volts</b> |
| ◆ <b>Position 2:</b> | <b>Heavy-gauge green wire – goes to chassis ground</b>   |
| ◆ <b>Position 3:</b> | <b>Heavy-gauge yellow wire – goes to ignition coil</b>   |
| ◆ <b>Position 4:</b> | <b>None (intentionally left open)</b>                    |

19. The red wire (connector position 1) goes to a switched source of +12 volts from the battery. You can pick this up from the wire supplying +12 volts to the ignition coil's primary terminal, if you wish. Dual-tower coils are generally not marked for positive (+) and negative (-) primary terminals (since it does not matter).

20. The power cable harness' heavy-gauge green wire (connector position 2) must go to a good chassis ground. A "good ground" means that it must have a low-resistance path to the metal of the main chassis and it must have a low-resistance path to the battery's negative (-) terminal. If these two things are not well-connected electrically, you will have problems. The ground wire is 12" long as supplied. If you want to make it shorter, you may, but it should not be extended. The chassis ground must be free of paint and be clean, bright metal.

21. The yellow wire (connector position 3) goes to one primary terminal of the ignition coil (the other primary terminal of the coil is connected to +12 volts). Again, terminal polarity is generally not marked on a dual-tower coil, and it does not make any difference.

22. Figure 1 shows how the power wiring should look when you're done. The pickup plate and its wires are left out of the diagram for clarity – only the wires that the installer is responsible for connecting are shown. If you are unfamiliar with wiring diagrams, wires that have a "dot" at their intersection are electrically connected to one another.

# ***PROBE ENGINEERING, INC.***

## **Installation Instructions, Model FS-02E Version 7.1**

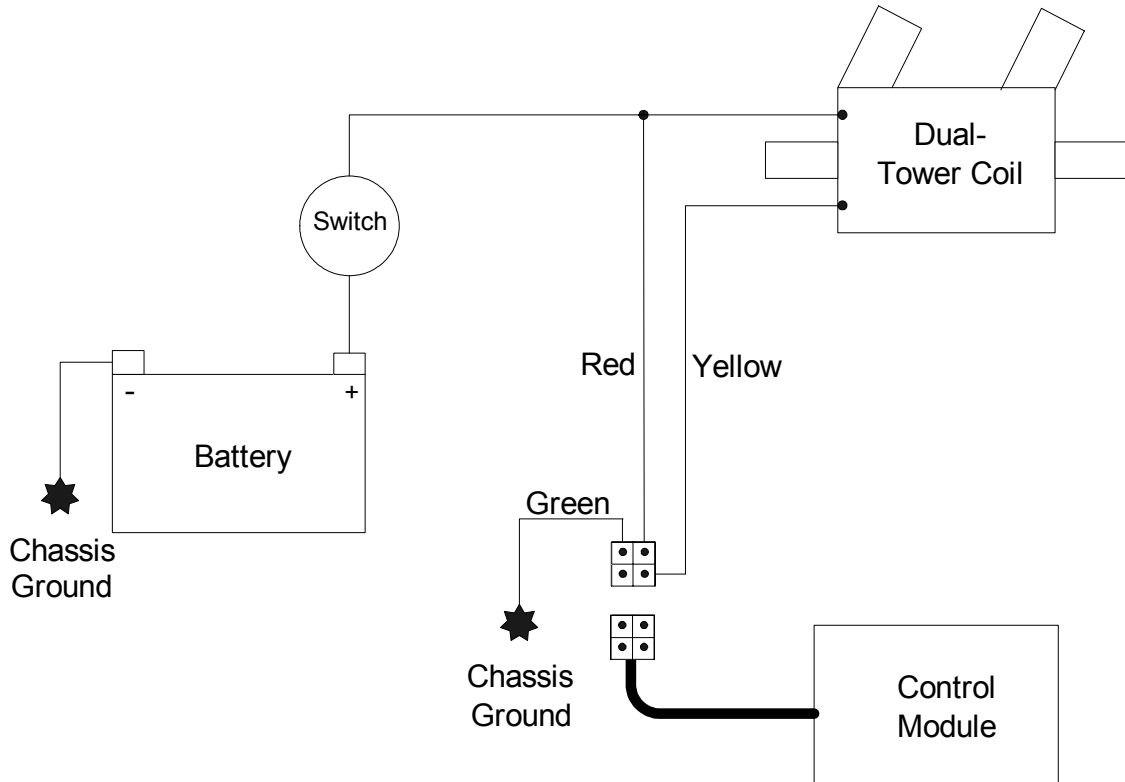

**Figure 1**

23. Plug the power harness connector into the control module. It's keyed, so it only goes one way, but it will be obvious. Make sure the connector is seated fully – the connector's retaining latch will engage with a “click” when it's fully home.
24. Shake the tube of medium-strength (blue) Loctite or equivalent thread-locking compound for a minute to mix it up.
25. Smear a couple of drops of thread-locking compound all the way around the points cam. Also smear a drop of thread-locking compound directly on the end of the points cam. Note the index mark stamped into the end of the cam; it looks a little like an exclamation point (!), but with no dot. You will use this mark as a guide to correctly align the trigger rotor to the cam.

# ***PROBE ENGINEERING, INC.***

## **Installation Instructions, Model FS-02E Version 7.1**

26. Take a look at the trigger rotor. It's shaped like a "top hat," and there is a small, round hole off-center in the top of the hat (don't confuse the hole with the end of the slot in the side of the hat section; the slot's for clearing the clamping ball, not for alignment). Align the hole in the rotor to the index mark stamped into the end of the points cam, and slide the rotor all the way over the cam until it bottoms out. Line up the cam's index mark so that it's centered in the little "window" created by the hole. It should look like this:

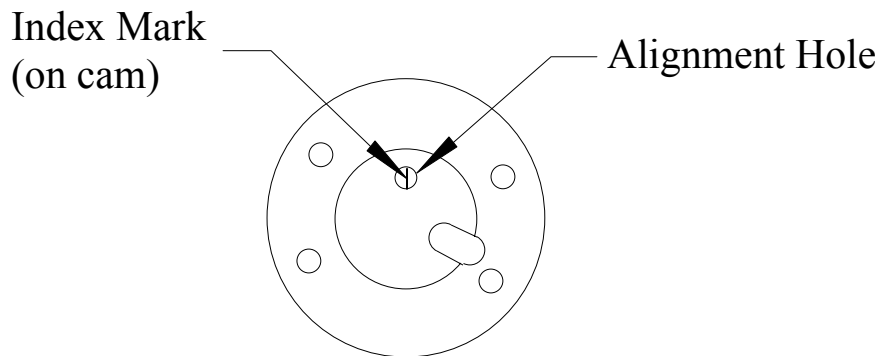

27. Slip the Rotor Clamp over the rotor. The ball attached to the clamp will engage the slot in the rotor – how it goes will be obvious. Slide the clamp down until it stops on the "brim" of the hat section
28. Carefully grab the "ear" at one end of the rotor clamp with the end-cutting pliers, and clamp down until the ear is deformed about 1/16" or so from its original profile. You've got to use end-cutters for this operation, because their jaws are perfectly parallel at all times as they close – diagonal cutters won't work. Don't pinch the ear off – we're just trying to squeeze it down a little. (The special tool available for crimping Oetiker clamps looks just like end-cutting pliers, but has blunt, not sharpened, jaws. Most folks don't have the special tool lying around. The end-cutting pliers work just the same, and are available at any hardware store.)
29. Grab the ear at the opposite end of the clamp, and deform it the same way you did the first ear in the previous step.
30. Go back to the first ear and squeeze it a little more, then return to the second ear and give it another little squeeze. By now the clamp should be pushing the ball against the surface of the points cam, forcing the opposite surface of the cam against the matching-contoured inner bore of the trigger rotor.

# ***PROBE ENGINEERING, INC.***

## **Installation Instructions, Model FS-02E**

### **Version 7.1**

31. Check the alignment of the index mark on the end of the points cam to the alignment hole in the end of the rotor. If the index mark is not still centered in the hole, grasp the rotor and turn it to realign the index mark. The rotor should turn on the points cam, with a little effort, until the Loctite sets up. Note that that if you try to reposition the rotor clockwise on the points cam, you will have to first overcome the initial turning of the points cam against the advancer springs.
32. Reconnect the battery.
33. Disconnect the spark plug caps and install a spare set of plugs into the caps. Lay the metal base of the plugs down so they contact the cylinder head surface.
34. Turn the ignition key to the “on” position. **NOTE: The following steps may take you more than a couple of minutes to accomplish, during which time the engine will not be running. The module’s “timeout” circuit will interrupt coil current 30 seconds after the power is first applied (if the engine is not rotated), and/or 30 seconds after the last engine rotation; when the timeout occurs, there will be a spark at the plug(s) that is unrelated to normal ignition timing. Since you may be turning the engine over intermittently during these steps, you may also be somewhat defeating the timeout circuit by continually re-setting it before the 30-second timeout, potentially putting abnormal thermal stresses on the module and the coils. If it takes more than four or five minutes to get to step #39, shut off the power, wait five minutes, then turn the power back on and complete the remaining tasks.**
35. Kick the engine through a couple of revolutions while keeping an eye on the spark gaps in the two spare plugs. The plugs should fire simultaneously, once per crankshaft revolution.
36. Using a 14mm socket or box-end wrench on the alternator rotor center bolt, slowly rotate the engine clockwise (in the “forward,” running direction) while watching the module’s red LED. The LED is illuminated during the coil’s “dwell” period, and goes dark exactly as the spark plugs fire. Rotate the engine through a couple of turns to get a feel for it; the “dwell” period (when coil current flows and the LED is lit) occupies 270 degrees of crankshaft rotation, and the “fire” period (coil current interrupted; LED dark) occupies the 90 degrees of crank rotation.
37. Stop turning the crank just as the LED goes dark (you will also hear the plugs spark at the same time, if it’s quiet enough and your ears are sufficiently keen). The LED should go dark near the point at which the alternator rotor’s “F” mark lines up with the timing indicator; this is the nominal idle-speed timing setting.



# ***PROBE ENGINEERING, INC.***

## **Installation Instructions, Model FS-02E Version 7.1**

38. The final ignition timing will be set with the engine running and with the auto-advancer at full spark lead (advance), but the LED/idle-timing check will tell you if the timing's close enough to start the engine. If the LED does *not* go dark close to where the F mark aligns with the indicator, loosen the pickup plate screws and rotate the pickup plate to get the timing correct, and then snug the screws back up. Rotating the plate in the direction of trigger rotor rotation (clockwise) will *retard* the timing; rotating the plate counter-clockwise will *advance* the timing.
39. Turn the ignition key to the "off" position.
40. Disconnect the spare spark plugs and reinstall the plug caps on their respective engine spark plugs.
41. Open the petcock and set the choke, as required.
42. Turn the ignition key to the "on" position.
43. Start the engine using the kick starter or the electric starter.
44. Warm up the engine a little bit, so that it will idle when you need it to.
45. Connect a xenon-flash type timing light to the right-hand cylinder's plug wire, and connect the timing light to the battery.
46. With the timing light aimed at the alternator rotor's timing marks, rev the engine up to the full-advance RPM level (3,300 RPM or so). If the timing light "freezes" the timing indicator between the two full-advance "hash" marks, your full-advance timing is correct, and you can tighten the pickup plate retaining screws.
47. If the timing is not correct (and chances are that it will be a little bit off, because the engine's internal advance-retard mechanism seldom has exactly the correct advance), shut off the engine, loosen the screws holding the pickup plate and rotate the plate to adjust the timing. For every 0.023" of rotation at the edge of the plate, the ignition timing will change about 2° at the crankshaft. Rotating the plate in the direction of trigger rotor rotation (clockwise) will *retard* the timing; rotating the plate counter-clockwise will *advance* the timing. After you've readjusted the timing, tighten the pickup plate retaining screws.
48. Restart the engine and recheck the timing. Repeat as required. If you run out of adjustment slot length in the pickup plate, grab the trigger rotor and slightly reposition it on the end of the points cam. (That's why we installed the rotor last – so the Loctite won't be set up at this point.) If you ran out of pickup plate slot length

# ***PROBE ENGINEERING, INC.***

## **Installation Instructions, Model FS-02E Version 7.1**

while trying to retard the timing, reposition the rotor slightly counterclockwise on the points cam. If you ran out of slot length while trying to advance the timing, reposition the rotor slightly clockwise.

49. Honda CA72/77 engines are sensitive to excessive timing advance, and can overheat and possibly seize if the full-advance timing is not correctly set – that’s why the timing must be adjusted correctly at the full-advance position. Once the full-advance timing is set, the timing at the normal idle speed should fall on or near the “F” mark on the alternator rotor. If the idle-speed timing is not correct when the full-advance timing is set properly, the problem is with the centrifugal advance mechanism. This is not an uncommon problem, and the error is usually *too much* advancer action, which results in retarded idle timing (closer to TDC) with the full-advance timing correctly set. Moderately retarded idle-speed ignition timing will not harm the engine, and if the resulting idle speed is slightly too low as a result, it can be corrected using the carburetor’s idle-stop adjustment screw.

50. When the timing is set and the pickup plate screws are tightened, turn off the ignition key, close the petcock, and reinstall the various covers and bodywork that you removed earlier.

### **Other details and notes:**

- ◆ The Model FS-02E ignition will work with stock ignition coils (about 4.5 ohm primary resistance), but OEM Honda coils from the sixties were not particularly high-quality components, and are often in terrible shape now, forty years on. For those wishing to use high-quality aftermarket coils, dual-tower coils with a primary resistance in the range from 4 to 5 ohms are recommended (Dyna and Accel are good sources of top-quality coils). The FS-02E system will operate safely with a coil primary resistance as low as 3 ohms, but current draw (i.e., the load on your already marginal charging system) increases with decreasing coil resistance, so you should be prepared to keep an eye on the battery’s state of charge when using a 3-ohm coil.

*For questions and/or assistance, contact:*

Mark Whitebook  
Probe Engineering, Inc.  
34661 Calle Rosita  
Capistrano Beach, CA 92624  
mwhitebook@yahoo.com